

HILLDAV

Digital Thermometer

Digital Thermometer

TC308K



TC308K Digital Thermometer

DIGITAL THERMOMETERS

TC308K Digital Thermometer

PRICE **RETAIL**
NO GST with GST

\$225.00 **\$247.50** **DITITAL INDICATOR**

Type '**K**' (BATTERY INCLUDED). with
THERMOCOUPLE—WIRED UP READY TO GO
Type 'K' single Input (Mini Plug)

- Auto Power Off
- 14mm high digit LCD display.
- Power supplied by 9v battery (supplied)
- Range Type K Input—50 to 1300 °C
- Accuracy +/- 0.3 % + 1°C
- Resolution 0.1 °C to 199.9 °C then 1°C
- Case is manufactured form hi-grade ABS plastic and in supplied with a moulded rubber boot which makes it ideal for studio conditions and perfect for you to just put in your tool bag for transport.
- Recalibration / Offset Screw on face
- Minimum / Maximum Function
- Mini plug well protected in top panel of Instrument
- Weight; 300g

With type 'K'
Thermocouple

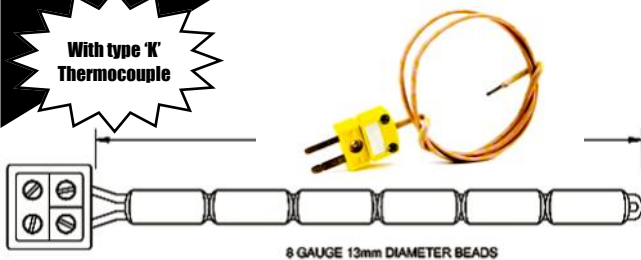

Spare THERMOCOUPLE with
LEAD & MINI PLUG.

\$87.05 **\$95.75** SPARE TYPE '**K**'

HILLDAV

Kiln Controllers & Thermocouples Kiln Controllers & Thermocouples



4 Pin Plug



4 Pin Socket

Thermocouple Type K & N



Type "R" Thermocouple

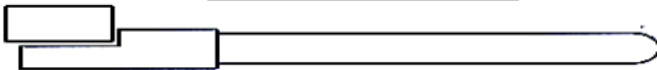

Ceramic Sheath

Compensating

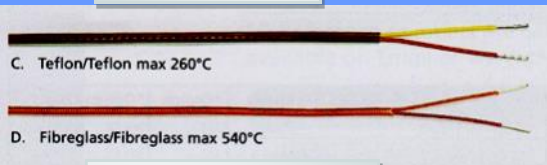

Standard Plug & Jack



Mini Plug & Jack

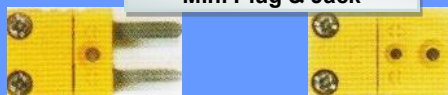

Energy Regulator 16

Energy Regulator 13

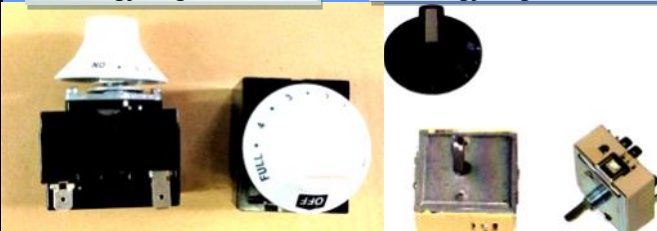

4 PIN PLUG & SOCKET

\$50.00	\$55.00	4 PIN PLUG
\$50.00	\$55.00	4 PIN SOCKET

THERMOCOUPLES

\$59.50	\$65..45	THERMOCOUPLE type ' K ' - - - 10" "K" Chrome/Alumel
\$59.50	\$65.45	THERMOCOUPLE type ' N ' - - - 10" "N" Nircosil/Nisil
\$312.00	\$343.20	THERMOCOUPLE type ' R ' - - - - 9" 'R' 13% Platinum/Rhodium.

CERAMIC SHEATH

\$64.00	\$70.40	CERAMIC SHEATH 10" for type ' K ' & ' N '
\$64.00	\$70.40	CERAMIC SHEATH 7mm for type ' R '

COMPENSATING WIRE

\$14.4	\$14.95	COMPENSATING WIRE GLASS COVERED TPYE ' K ' ' N ' & ' R '
\$13.90	\$15.30	COMPENSATING WIRE PLASTIC COVERED TPYE ' K ' ' N ' & ' R '

PANEL JACK & SOCKET

\$48.19	\$53.00	Standard size JACK type 'N' ' K ' & ' R '
\$36.00	\$39.60	Standard size PLUG type 'N' ' K ' ' R '
\$35.88	\$39.47	Mini size JACK type ' K '
\$55.95	\$61.55	Mini size PLUG type ' K '

ENERGY REGULATOR

\$58.00	\$63.80	EGO	13amp with KNOB
\$70.00	\$77.00	SUNVIC	16amp with KNOB

HILLDAV

Contactors, Switches & Other Control Equipment.

Contactors, Switches & Other Control Equipment.

SMC- 22 40AMP 3 Pole , SMC40 60AMP 3 pole

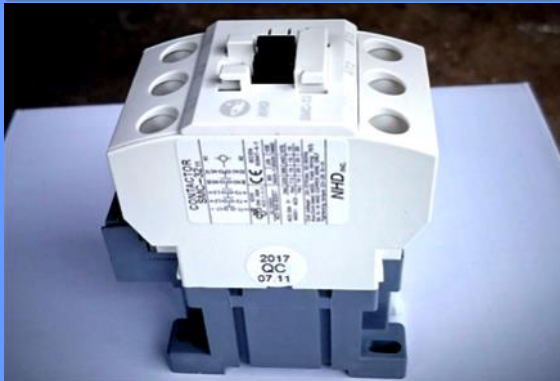

735-2C-C1

Door Switch

Used on Hilldav & Ward Kilns



Door Switch

Used on Cesco & other Kilns



Door Latches

Tetlow & Ward



PRICE RETAIL ELEMENT CONTACTORS

NO GST with GST

\$88.00	\$96.80	SMC-22	3 Pole, 40 amp.
\$120.00	\$132.00	SMC-40	3 Pole, 60 amp.
\$50.00	\$55.00	Power Relay 735-2C-C1	

DOOR SWITCHES

\$41.15	\$45.60	DOOR SWITCH	HILLDAV, WARD
\$49.45	\$49.45	DOOR SWITCH	TETLOW.
\$56.00	\$60.60	DOOR SWITCH	CESCO & other kilns.

DOOR LATCHES

\$130.50	\$143.55	HILLDAV "T" Type	
\$62.00	\$68.20	WARD "T" Type.	
\$42.00	\$56.20	WARD, TETLOW	Small kiln model

KILN BUNGS

\$54.00	\$59.40	HILLDAV	
\$12.00	\$13.20	UNIVERSAL	
\$49.50	\$54.45	TETLOW	

HILLDAV

Kiln Sitter Parts Kiln Sitter Parts

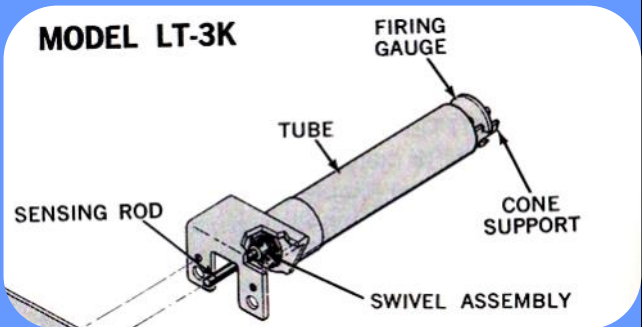
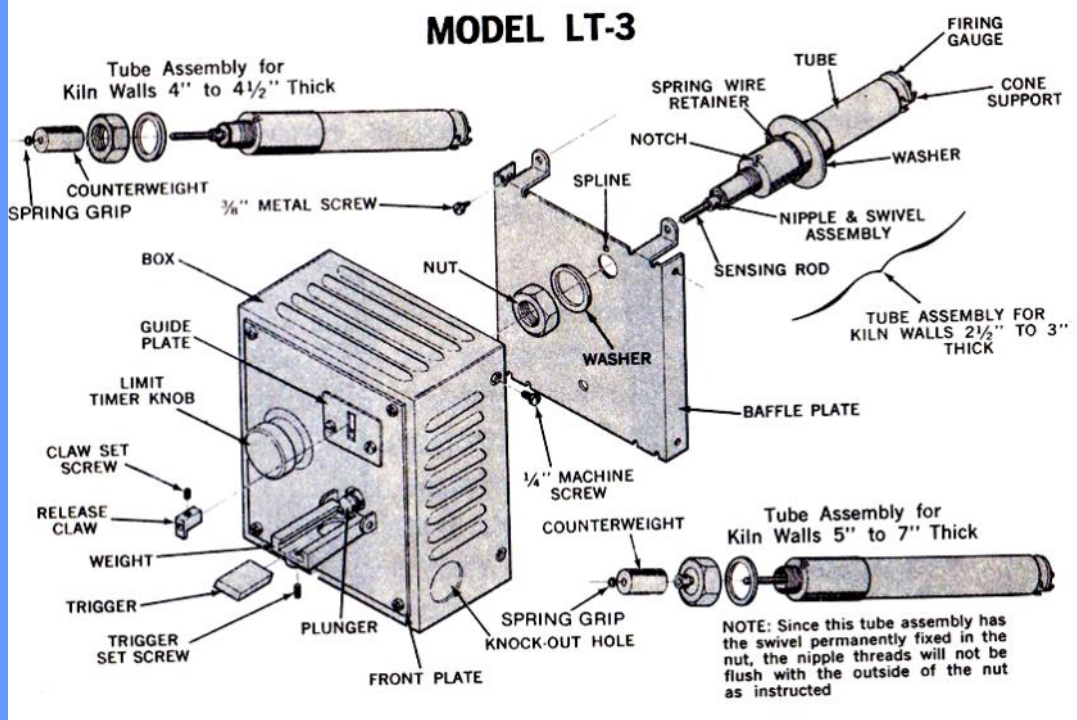

KILN SITTER PARTS

PRICE NO GST	RETAIL with GST	
\$430.00	\$473.00	TUBE ASSEMBLY LT-3K (long) #70A (For Top loading kiln such as Duncan , Paragon)
\$430.00	\$473.00	TUBE ASSEMBLY LT-3 (P/6") (For kiln with a wall thickness of 6" or more)
\$32.50	\$35.75	SENSING RODS (All Lengths)
\$29.00	\$31.90	CLAW ASSEMBLY
\$18.40	\$20.25	FIRING GAUGE
\$30.40	\$33.45	CONE SUPPORTS (Pair)



Firing Gauge



Cone Supports